

Alumina based technical ceramics

NABALOX®, GRANALOX®

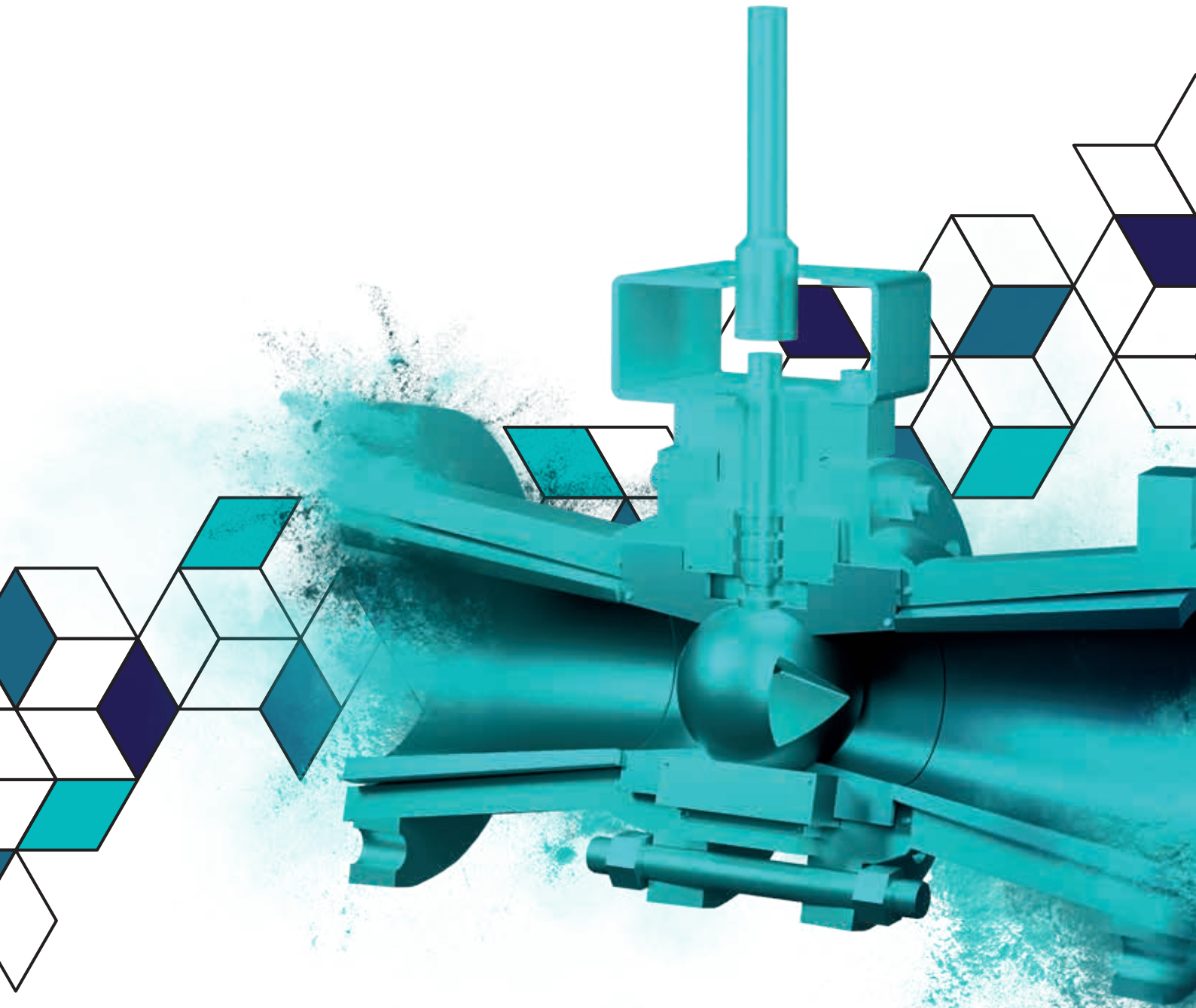

Nabaltec

Content

01 NABALOX® calcined aluminas

NABALOX® for technical ceramics	06
---------------------------------------	----

02 Feedstock preparation

Milling	09
Mixing	11
Spray drying	12

03 Forming processes

Uniaxial compaction	19
Isostatic compaction	21
Slip casting	22
Additive manufacturing	22
Extrusion	23
Injection moulding	23
Green machining	24

04 Heat treatment

Debinder and Sintering	26
------------------------------	----

05 Finishing

The background of the page features a large, stylized graphic of a calcined aluminium structure. It consists of a central teal diamond shape, a dark blue triangle to its right, and a teal triangle to its bottom right. These shapes are surrounded by a complex arrangement of white and dark blue hexagons and rhombuses, some of which are filled with teal or dark blue, creating a 3D effect of stacked layers.

NABALOX[®]
calcined aluminium

NABALOX® calcined aluminas



Rotary kiln for calcination of basic **NABALOX®** grades.

Nabaltec is a worldwide leading producer of synthetic raw materials. These include: General high performance aluminas (**NABALOX®**, **GRANALOX®**).

Due to their outstanding homogeneity, Nabaltec products are characterized by highly consistent properties which provides significant advantages in their mechanical, thermal, electrical and chemical properties, along with an excellent price-to-performance ratio. These characteristics make **GRANALOX®**- and **NABALOX®**-aluminas an ideal raw material for the demanding applications and needs of technical and engineering ceramics, while offering a maximal processing safety.

Typical benefits:

- reduced sintering temperatures
- high sintered densities and defined shrinkage
- improved mechanical strength
- excellent thermal fatigue and corrosion resistance

Nabaltec produces calcined aluminium oxides for a wide range of application areas. High class raw materials are selected according to standardized parameters of quality. By working within tightly controlled production parameters, Nabaltec is able to control and tailor the degree of calcination from very “soft” to very “hard” by sophisticated temperature regulation of the rotary kilns. This high level of control allows the production of aluminas with defined properties such as α - Al_2O_3 -content, size of primary crystals and specific surface area (s. table). In addition, using our patent-registered technique Nabaltec is able to reduce the Na_2O -content to levels below 0.1 %. The high level and long term experience of our staff guarantees a reliable and consistent high quality product.

Typical chemical composition of **NABALOX®** raw materials for engineering ceramics.

Typical chemical analysis	[%]
Al_2O_3	> 99
SiO_2	0.04
Fe_2O_3	0.02
Na_2O	≤ 0.1

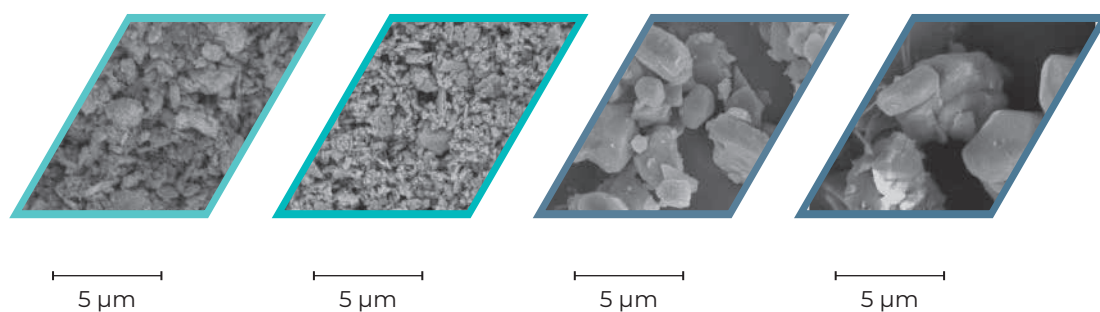
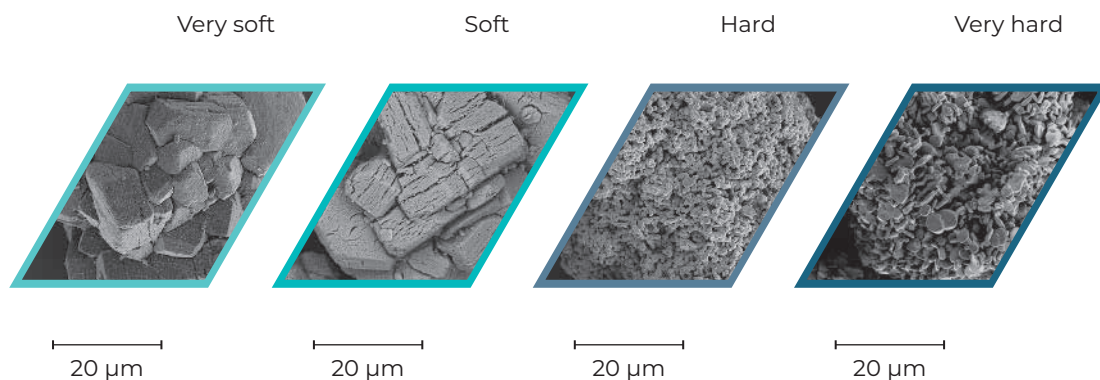

Primary crystal size



Specific surface area (BET)



Crystal modification



Calcination temperature

Size of primary crystals, specific surface areas, α-Al₂O₃-content of different calcination degrees.

NABALOX® for technical ceramics

The low soda **NABALOX**® grades (0.1 % Na₂O) are used for technical ceramics, e.g. NO 104 RA, NO 105 RA, along with milled derivatives of these basic aluminas (NO 325, NO 625-10, NO 713-10, NO 725-10...). It is the customer's decision whether to begin feedstock preparation with the unmilled coarse aluminas or to directly use fine milled, deagglomerated Al₂O₃-grades. Furthermore, different sophisticated raw material formulations such as **GRANALOX**® for various forming methods are available. Therefore as an immediate product, "ready for pressing", Nabaltec offers the **GRANALOX**®-product range according to defined material classes.

Spray-dried aluminas are widely used for the production of high performance

technical ceramics. To achieve their exceptional properties, careful selection of all raw materials is vital. Based on our long experience in development and production of calcined aluminas, Nabaltec is operating the world's most up-to-date production facility for **GRANALOX**®.

With the **GRANALOX**® and **NABALOX**® grades, Nabaltec offers alumina based products of high quality, suitable for a wide diversity of shaping methods. The "ready-to-press" ceramic bodies, **GRANALOX**®, are formulated with all necessary inorganic and organic additives and can be directly used 'as supplied'. The binder-free (C-) grades are mainly designated for a diverse range of moulding technologies.

Classification according to IEC 672-1 (in excerpts)	Unit	C 786	C 795	C 799
Al ₂ O ₃ content	[%]	86 – 95	95 – 99	> 99
Mechanical				
Density	[g/cm ³]	3.4	3.5	3.6
Bending strength (4 point)	[MPa]	250	280	300
Elastic modulus E	[GPa]	220	280	300
Electrical				
Dielectric strength	[kV/mm]	15	15	17
Electrical resistance (20 °C)	[Ω*m]	10 ¹²	10 ¹²	10 ¹²
Electrical resistance (600 °C)	[Ω*m]	10 ⁶	10 ⁶	10 ⁶
Thermal				
Coefficient of linear expansion (30 – 600 °C)	[10 ⁻⁶ K ⁻¹]	6 – 8	6 – 8	7 – 8
Specific heat capacity	[Jkg ⁻¹ K ⁻¹]	850 – 1050	850 – 1050	850 – 1050
Thermal conductivity	[Wm ⁻¹ K ⁻¹]	14 – 24	16 – 28	19 – 30
Max. temperature of usage	[°C]	1400	1400 – 1500	1400 – 1700

The alumina content of the **GRANALOX**[®] grades ranges from 92 to 99.8 %, in compliance with the material classes C 786, C 795 and C 799 of the standard IEC 672-1.

The quality of raw materials is of key importance for all properties of the final ceramic parts. As an alumina producer, Nabaltec controls and guarantees consistency of the essential physical and chemical feedstock and powder properties (e.g. grade of calcination, grain size distribution, primary crystal size, specific surface area, grinding behaviour, thermal reactivity...).

GRANALOX[®]-products with an alumina content < 99 % are predominantly characterized by a glassy phase sintering mechanism. These basic aluminas contain specifically selected inorganic additives in different proportions. A variation in the type and amount of these additives enables Nabaltec to optimize **GRANALOX**[®] bodies for many different applications.

GRANALOX[®] grades with an alumina content > 99 % are free of inorganic additives. The properties of the ceramic are mainly affected by the type of alumina and organic additives.

Nabaltec aluminas, as well as ceramic bodies, are produced under consistent and rigid quality control of the pressed and sintered density, sinter shrinkage, loss on ignition, chemistry and granulate prop-

erties such as granulate size, moisture content, and bulk density. The application areas of **NABALOX**[®] and **GRANALOX**[®] ceramic bodies are focused on technical applications where the characteristic and advantageous properties of (mainly) α -alumina (corundum) are required.

Ceramic products with:

- exceptional hardness,
- high wear resistance,
- excellent thermal creep resistance,
- remarkable electrical insulation,
- high thermal conductivity,
- superior corrosion resistance,

are preferably produced from **NABALOX**[®] / **GRANALOX**[®] grades.

Exceptionally high surface finish characteristics can be achieved from a number of specifically optimized **GRANALOX**[®] products.

As a further service, Nabaltec offers customer-specific development and supply of ceramic bodies with individual mineral and binder compositions.

In the following the benefits of our **NABALOX**[®] / **GRANALOX**[®] grades for engineering ceramics are described. In addition, optimal performance depends on the processing step that are used for Nabaltec products.



Feedstock preparation

Feedstock preparation

The choice of the right raw materials determines the properties of the final technical ceramic product.

Intensive homogenization of the raw materials is required to achieve a technically accurate feedstock. Their preparation is precisely tailored for the favoured end-forming process, such as isostatic pressing, injection moulding, additive manufacturing...

The forming process used to create the green part is dependent on the complexity of the ceramic part and on the production volume.



Fully automatic weighing system for **NABALOX®** / **GRANALOX®**-formulations.

Milling

Milling is one of the most appropriate ways to homogenize powder raw materials.

For high performance ceramics it is important to deagglomerate the **GRANALOX®** precursors (e.g. **NABALOX®** aluminas). Otherwise, the remaining agglomerates will generate defects in the final engineering ceramics, which leads to reduced strength and performance.

Fine particles are thermally more reactive than coarser ones and lead to higher sintered densities at lower temperatures.

The challenge of fine alumina particles is the poor compaction behaviour. High

pressing forces are required to arrange the particles close to each other to have particle-to-particle contact for the sintering process. This is important to achieve densification of the ceramic material that is close to the optimum conditions.

On the other hand, if agglomerates are still present prior to the forming process, defects will be formed in the sintered ceramics and lead to a lower strength (e.g. mechanical).

Nabaltec offers both, basic calcined aluminas and also deagglomerated grades. Moreover easy to disperse raw material **NABALOX®**-formulations (92 – 99.8 % Al_2O_3) are available.

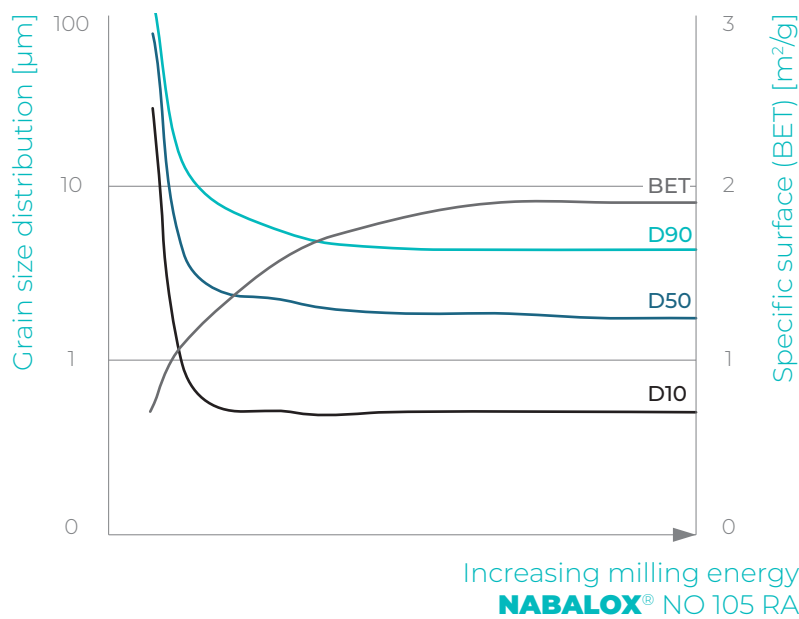
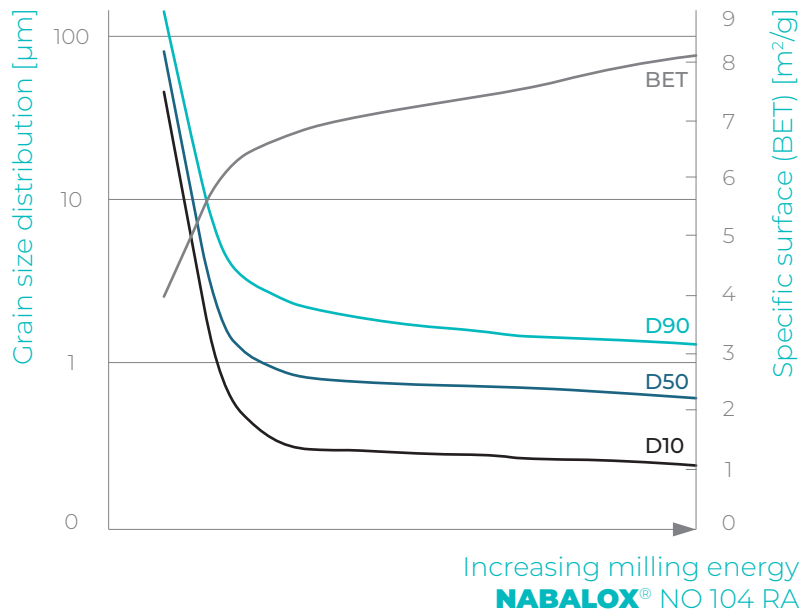

Comparison of grinding behaviour of NO 104 RA and NO 105 RA.

Grinding behaviour of NO 104 RA and NO 105 RA are shown in image above. Deagglomeration of 2 µm primary crystals of NO 105 RA aggregates needs less milling energy compared to fine 0.5 µm primary crystals-agglomerates of NO 104 RA, therefore high energy milling is necessary.

Using our binder free "C"-types is the technical best way to start with completely deagglomerated grades to prepare the feedstock for challenging forming methods (e.g. injection moulding, slip casting...).

Mixing

The diagram below shows a grain size distribution of a "standard-grade" alumina (red), which is accompanied by some coarse agglomerates of approximately 7 – 8 μm . This can lead to a disturbance of the particle packing during the compaction process. The particle size distribution of the fine milled, deagglomerated grade (black line) shows that the coarse agglomerates at approximately 8 μm have disappeared completely.

For injection moulding feedstocks it also is necessary to homogenize **NABALOX**[®] / **GRANALOX**[®] aluminas and the binder-formulation as intensively as possible.

The SEM-images (next page) of two milled alumina grades visualize potential problems if this homogenizing process is not sufficiently intensive or homogeneous enough. In partially milled grades, agglomerates are still present (red circles).

In high energy milled grades the coarse agglomerates are destroyed. A low degree of defects combined with a homogeneous microstructure of the ceramic will be achieved after the sintering process.

In contrast, the microstructure of the ceramics made from a completely deagglomerated grade (right SEM) reveals that almost no defects are detectable. A high sintered density of 3.93 g/cm³ shows that there is only a limited number of small defects, leading to a ceramic material with excellent ceramic properties.

Especially for injection moulding feedstocks, agglomerates cause difficulties during the forming process. Organic binders as well as alumina particles cannot be distributed equally in the formulation, which leads to poor filling behaviour of the mould and therefore void formation after sintering.

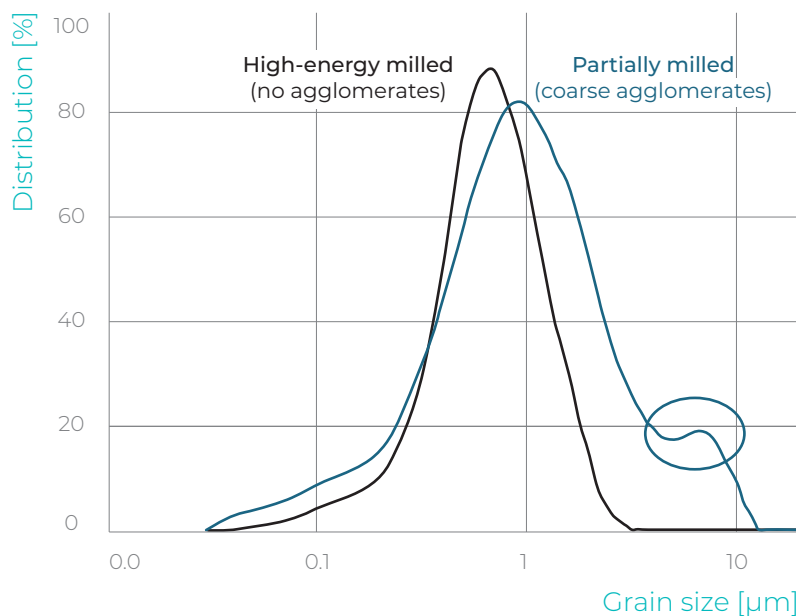

Deagglomeration via high-energy milling. Agglomerates: Red circle.

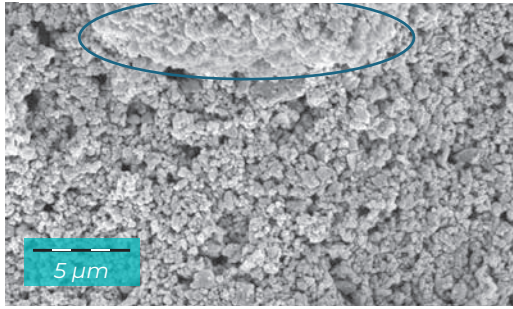

Partially milled alumina (agglomerates remaining).

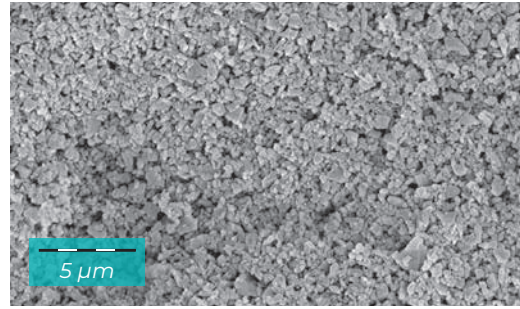

High-energy milled (no agglomerates).

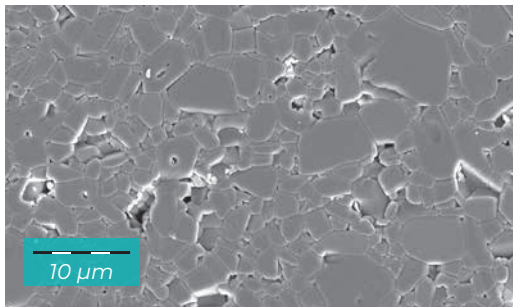

Partially milled grade sintered density 3.90 g/cm³.

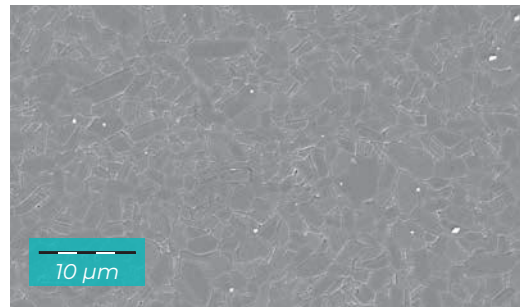

High-energy milled sintered density 3.93 g/cm³.

Thermally etched surfaces of polished 99.7 % Al₂O₃ ceramics, prepared via different homogenization intensities (sintering conditions 1600 °C, 100 MPa).

Spray drying

Flow chart of **GRNALOX[®]**-production.

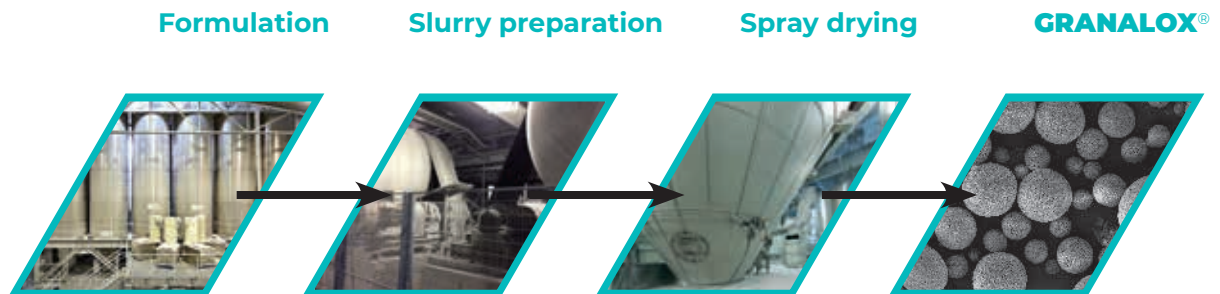

- **NABALOX[®]**
- natural minerals
- water
- dispersant

- milling
- production control
- addition of organics
- homogenization

- atomization of slurry into fine droplets
- drying of droplets by hot air

- good powder flowability
- intensive control of ceramic properties

While principle of spray drying process is relatively simple, the technical details are extremely sophisticated. Such high levels of technical and expert knowledge are required for premium quality **GRANALOX**[®] ceramic bodies.

Nabaltec ceramic bodies are produced under consistent and rigid quality controls of pressed and sintered density, shrinkage, porosity.

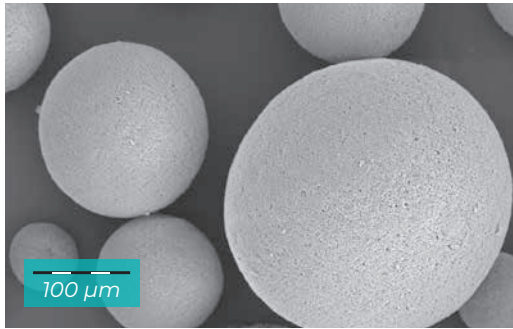

Spray dried **GRANALOX**[®], coarse grade.

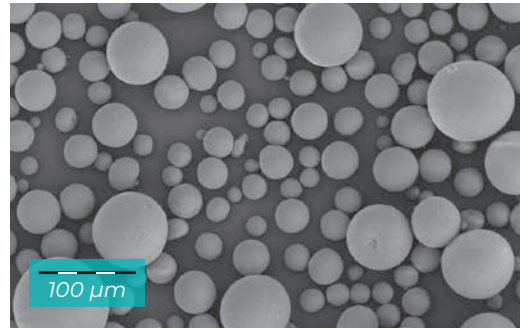

Spray dried **GRANALOX**[®], fine grade.

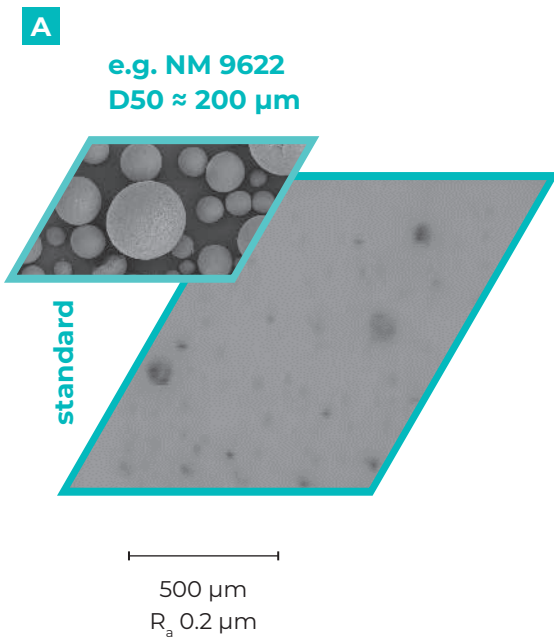

3-point-bending strength 310 MPa

- improved flowability of powder
- recommended for larger sized parts

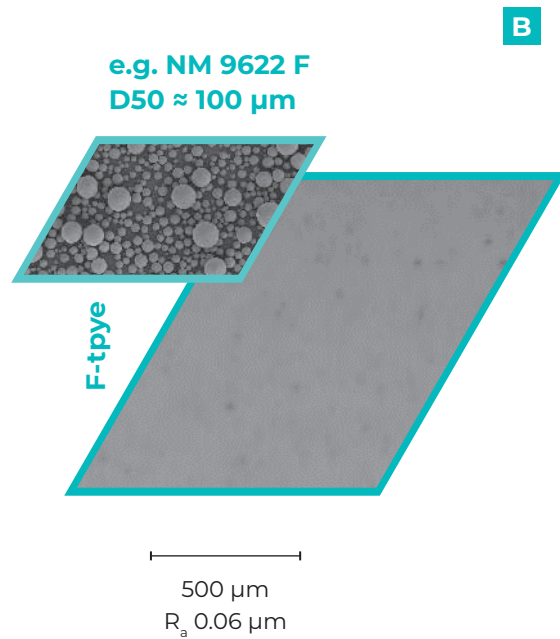

3-point-bending strength 340 MPa

- less porosity, smaller pinholes for improved polishing
- easy mold filling, especially for small parts

Different surface qualities depending on granulation size (A 200 μm, B 100 μm).

In particular, the size of the granules have a strong influence on the properties of the resulting ceramic part. Image A shows a polished surface of a ceramic processed from a 200 μm granulate. Compared with the surface on Image B, where a much finer (100 μm) granulate was used, a denser and more homogeneous surface quality is formed. Commonly, the 200 μm -powder is good for the production of larger sized parts caused by the improved flowability of coarse granulates into the moulds. Whereas using a fine powder leads to a much more homogeneous (but slower) mould filling, with a reduced amount of small pinholes between the single granules to provide a higher surface quality after sintering and polishing. There is also an effect on the mechanical strength by using different granulate sizes produced from the same material. On measuring the 3-point-bending strength on the two ceramics a somewhat lower strength is seen for parts made of the coarse granules, compared to the finer variant. This may come from the larger content of inter-granular defects, which leads to larger defects and thus a decreased strength.

Modifying organic components

To reach a high density after sintering, it is essential to start with a homogeneous and defect-free green part. To achieve this target, the pressing stage of granulate is an important step. The mould is filled with granules of different sizes and all granules have to be destroyed equally to be (rest) agglomerate-free. This can be achieved by adjusting the formulation of the organic components. Therefore, selecting the right organic ingredients is highly important. In addition it is vital to know as much about the future manufacturing steps and the size and shape of the ceramic parts. Depending on the part geometry and the amount of necessary green manufacturing, a "soft" or "brittle" organic formulation is chosen. Nabaltec offers both, fine 100 μm -granulate and coarser 200 μm grades, and our customers can use the benefit of both types: The improved flowability of coarse granules or the resulting better ceramic surface quality achievable via the F-types.

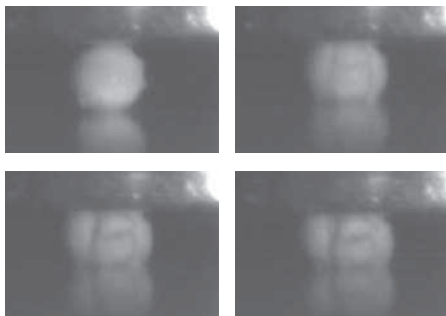

Sequence of breaking during compaction.

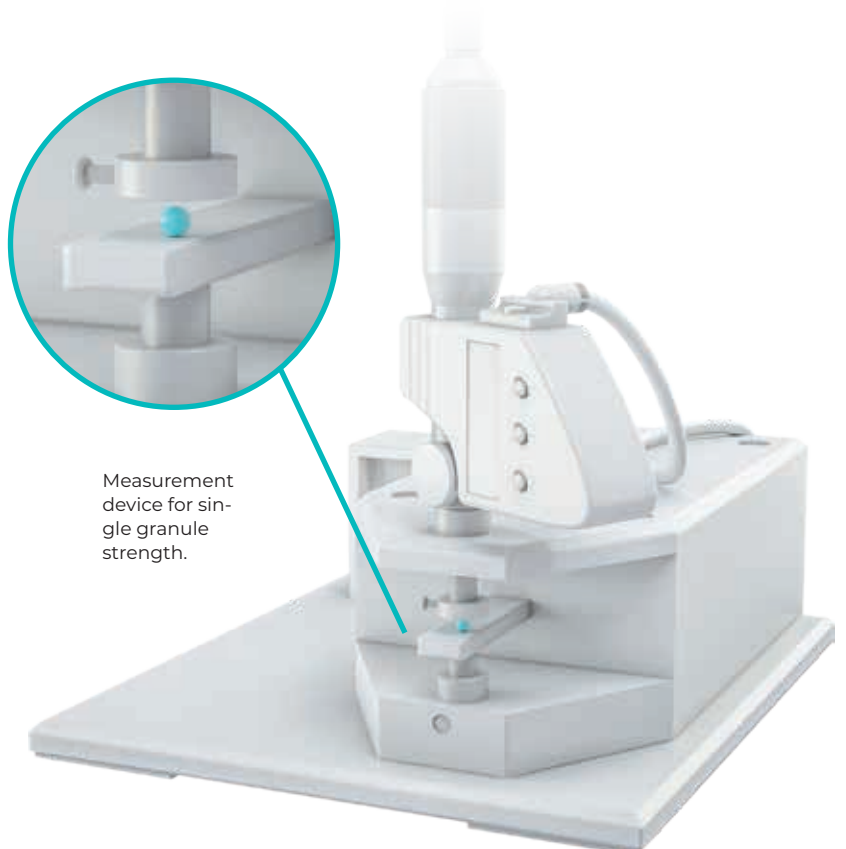

Measurement device for single granule strength.

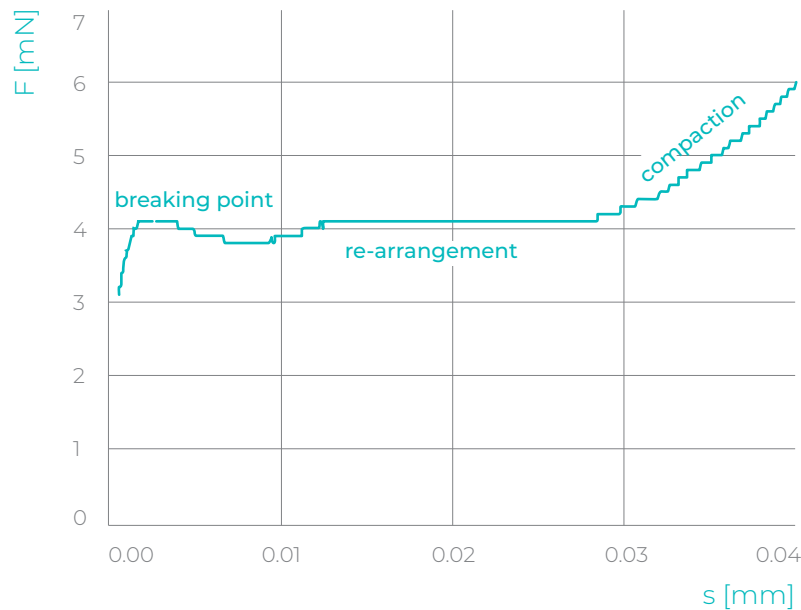

Force/path diagram shows different steps during granule breaking.

For producing high quality engineering ceramics by uniaxial compaction, a very soft organic formulation is often used. For formulations that need a higher green strength for very complex geometries with thin walls, or small ligaments, a harder composition has to be chosen.

For testing the behaviour of different organic formulations we use the "single-granule-strength"-test at Nabaltec. This experiment is done as follows: From a representative amount of granulates with the desired formulation a sieve fraction (depending on the type of spraying size) is taken. This has to be undertaken because very small granules behave differently to coarse granules

of the same granulate as soon as it comes to compaction. This is due to the different effective temperatures and drying times of the granules in the spray drying process. For the test, a single granule, as round as possible, is placed in the compaction device. The test is a standardized compaction test by taking a force-path-diagram. The graph shows that with increasing compaction the granule breaks at a distinct force, typical for a certain binder formulation. After breaking a re-arrangement of the granule pieces and further compaction takes place. These pieces are finally totally compressed. It is important to take a representative number of granules to achieve representative results.

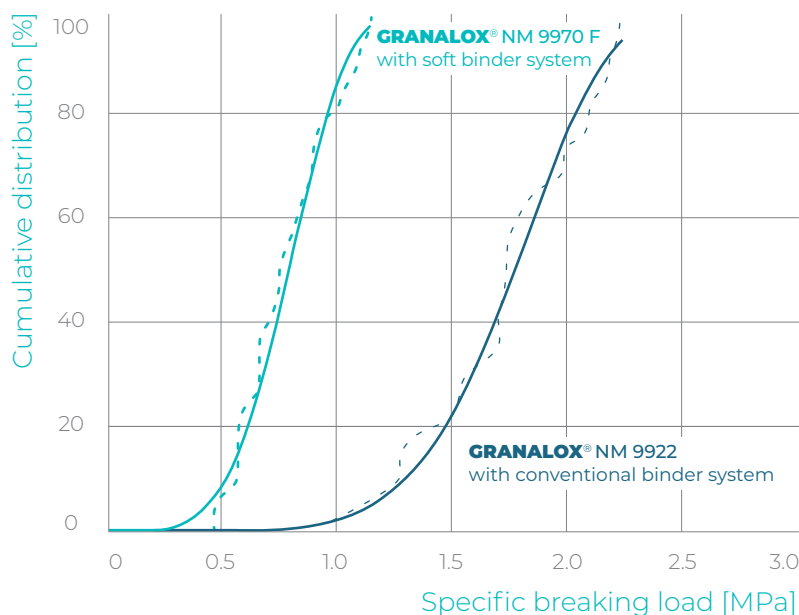

Comparison measurement of single granule breaking strength of two different binder types.

The data of the single-granule-test can be evaluated by different methods in order to acquire results for the prediction of granulate compaction for the "real" pressing process. To judge the behaviour of organic formulations a common evaluation is plotting the cumulative distribution against the specific breaking loads. The above figure shows a plot of the compaction test of two different organic formulations. A conventional 99.7 %-alumina granulate (red line) shows in production a typical compaction

behaviour. By modifying type and amount of the organic ingredients the pressing behaviour can be optimized (blue line). The mean breaking load for optimized granulates is reduced to a lower favoured pressure. Furthermore all granules have almost the same breaking load, which leads to a homogeneous green strength since all granules will break at a same similar force. By having access to this high sophisticated method, Nabaltec is able to tailor the pressing/compaction behaviour of **GRANALOX®**-types.

Typical chemical composition of sintered **GRANALOX®** types [%]

GRANALOX®	Al₂O₃	SiO₂	CaO	MgO	ZrO₂	Na₂O	Fe₂O₃	K₂O
NM 9212 (E, F, G, MS)	92.4	2.4	2.2	2.7	-	max. 0.1	0.05	-
NM 9510 F	95.0	2.6	2.2	-	-	max. 0.1	0.05	-
NM 9620 F	95.8	3.0	-	0.9	-	max. 0.1	0.05	-
NM 9622 (F, FS, W)	96.0	1.7	0.8	1.4	-	max. 0.1	0.04	-
NM 9634 F	96.0	2.0	-	0.8	1.0	max. 0.1	0.03	-
NM 9816	97.6	0.8	0.7	0.6	-	max. 0.1	0.03	-
NM 9916 F	99.6	-	-	0.2	-	max. 0.1	0.02	-
NM 9922 (F, I)	99.7	-	-	0.08	-	max. 0.1	0.02	-
NM 9970 F	99.7	-	-	0.08	-	max. 0.1	0.02	-
NM 9980 F	99.7	-	-	0.08	-	max. 0.1	0.02	-
NM ZTA12	87.7	-	-	0.08	12.0	max. 0.1	0.02	-

Schematics of main physical properties of different GRANALOX®-types

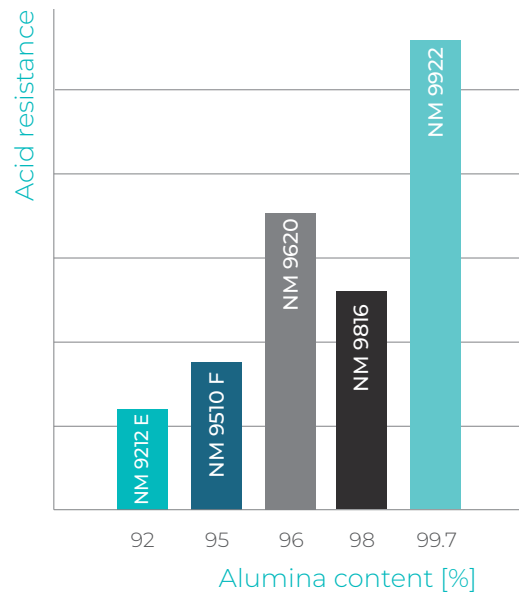
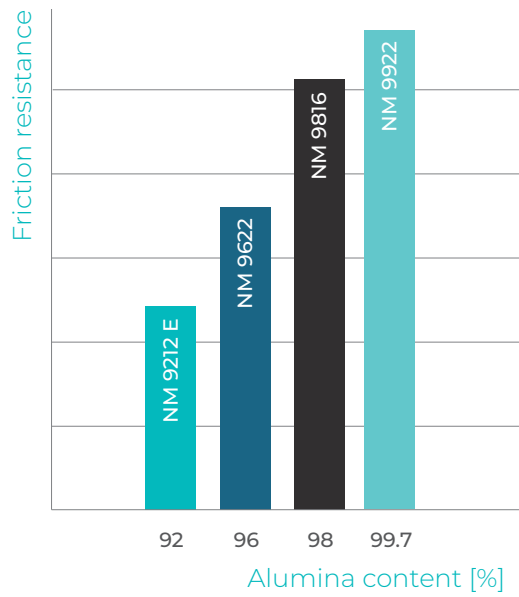
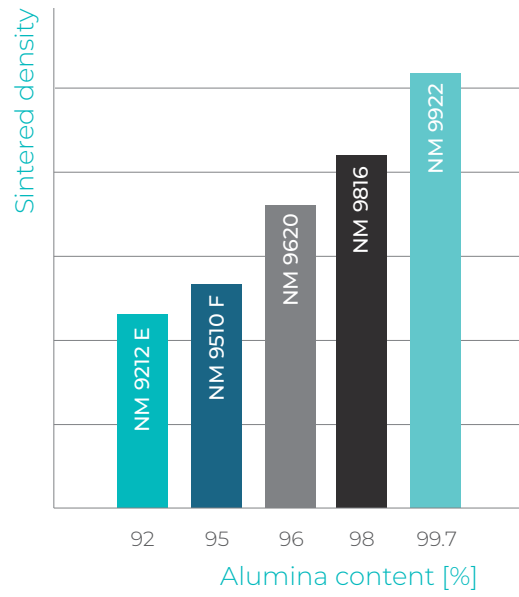
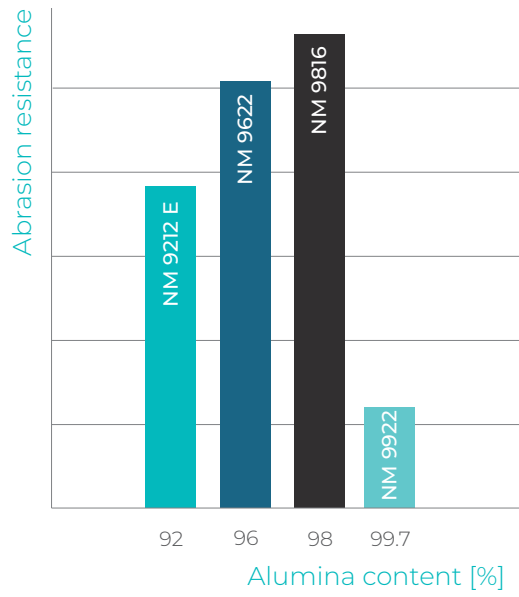



Forming processes

Uniaxial compaction

Main factors

- homogeneous mould filling and granule compaction
- reproducible sinter shrinkage
- low mould sticking
- high axial/radial compaction ratio

Characteristics

- very cost effective for big lot sizes
- for easy geometries

Recommended GRANALOX®

NM 9212 (E, F, G, MS), NM 9510 F, NM 9620 (F),
NM 9634 F, NM 9622 (F, FS, W),
NM 9816, NM 9922 (F), NM 9970
F, NM 9980 F, NM 9991 F

Recommended NABALOX®

NO 325, NO 613-10, NO 615-10, NO 625-10,
NO 625-31, NO 713-10, NO 725-10

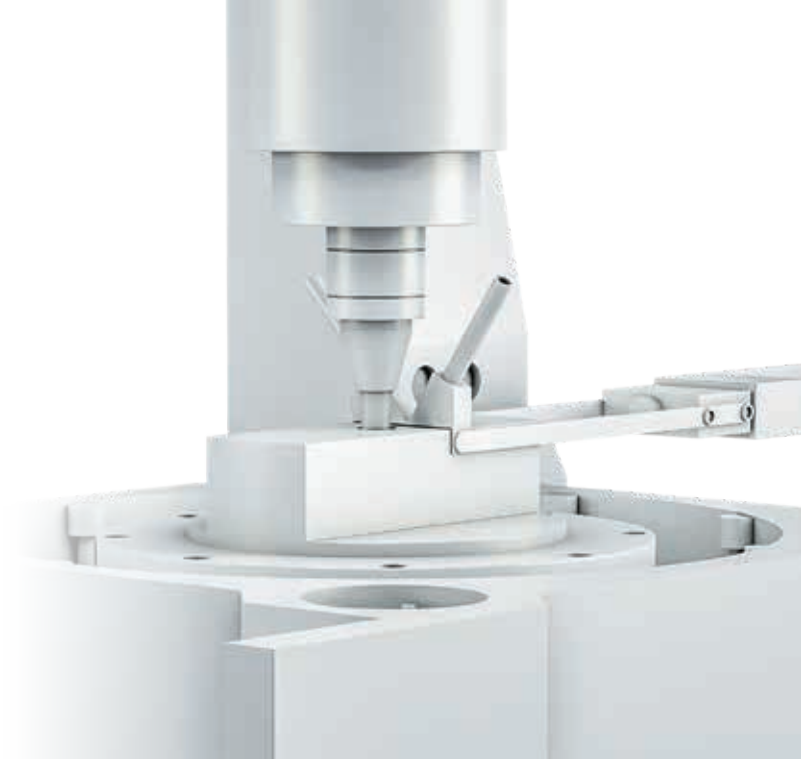

Good and bad filling behaviour of fine and coarse granulates

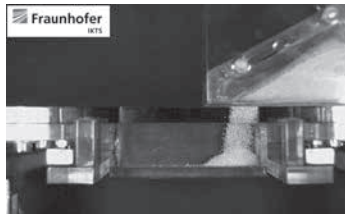

Coarse granulate "I" – 50 mm/s.

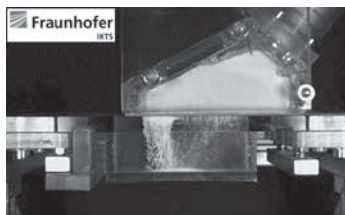
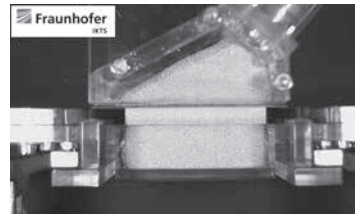
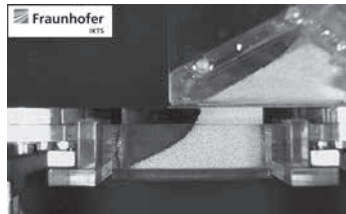

Fine granulate "II" – 50 mm/s.

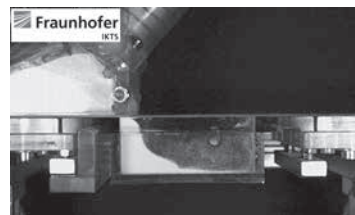

The filling with two different types of granulates is shown above, whereas granulate "I" is coarse (D50: 200 µm) and "II" is fine, e.g. **GRANALOX®** "F"-types (D50: 100 µm) with an optimized granule size distribution. During filling using granulate "I" (filling speed of 50 mm/s) the die is completely packed. In contrast, granulate "II" is not able to fill the complete mould, even when a slower filling speed is employed.

Nabaltec can adjust the granulate size distribution to achieve a fine powder to reach high quality ceramic surfaces after sintering, in combination with an improved mould filling.

Organic components are used to either achieve a high green strength or a good compaction behaviour of the alumina particles. These two aims cannot be ful-

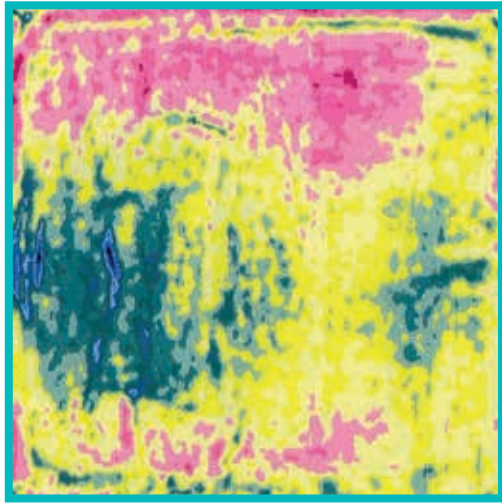

High density: Red
Low density: Black



Ultrasonic scan of ceramic plate (green part) shows density differences caused by inhomogeneous mould filling.

filled at the same time, but there are some organics which are appropriate to get both necessary granulate properties. The pressing behaviour can be optimized by reducing the wall-to-particle and the internal particle-to-particle friction. Typical organic binders which are used in engineering ceramics are shown on the right.

The success of the following powder compaction can be tested by ultrasonic-scanning, shown on picture above. An inhomogeneous green density over the plate (shown by different colours) is detected. An inhomogeneous compaction ratio during sintering leads to a poor, mechanical behaviour, for example, of the finished plates at their final application.

As the process of uniaxial pressing is used for the production of large lot sizes in a cost effective way, the sticking behaviour of the used granulate is a main factor. This effect is dependent on the organic formulation, especially if it is caused by the used press-

ing aids in conjunction with the granulate moisture. Furthermore, the influence of the climate (temperature, humidity) during the forming process plays influences the compaction behaviour. During the pressing cycle, material adhesion occurs on the upper and/or lower punch. This can become worse during following pressing sequences and leads to negative and visible effects on the green body's surface quality. The press has to be stopped and the punches have to be cleaned before the level of material adhesion becomes too great, which decreases the production output. If the cleaning cycles are not adjusted properly, the mould can also be damaged. Nabaltec has developed several grades to decrease this sticking behaviour significantly by using tailored organic formulations (s. table below).

Typical anti-sticking grades of GRANALOX®:

- NM 9212 G
- NM 9620
- NM 9622 W
- NM 9816
- NM 9970 F

(s. TDS: Nabaltec.de)

Typical organic additives for dry pressing techniques

Dispersants	Binders	Pressing aids
organic acids	poly vinyl alcoholates	fatty acids
poly acrylates	poly acrylates	poly ethylene glycol
		waxes

Surface defects on pressed part



Pressing cycles without tool-cleaning.

Adhesion on punch/mould causes surface defects on pressed parts.

Isostatic compaction

Main factors

- fine powder (F) for homogeneous filling
- low internal powder (particle/particle) friction
- high green strength for machinability

Characteristics

- high green machining effort
- very homogeneous powder compaction
- for small lot sizes and prototypes

Recommended **GRANALOX**[®]

NM 9212 F, NM 9510 F, NM 9620 F, NM 9634 F,
NM 9622 F, NM 9622 FS, NM 9916 F,
NM 9970 F, NM 9980 F, NM 9922 I,
NM 9991 F, NM ZTA12

Recommended **NABALOX**[®]

NO 325, NO 613-10, NO 615-10, NO 625-10,
NO 625-31, NO 713-10, NO 725-10



Slip casting

Main factors

- easy dispersable raw materials
- high casting rates
- low water demand

Characteristics

- complex/large geometries
- production relatively slow
- bad surface quality

Recommended NABALOX®

NO 325, NO 613-10, NO 615-10, NO 625-10, NO 625-31, NO 713-10, NO 725-10, NO 9212 C, NO 9622 C, NO 9915 C, NO 9922 C, NO 9980 C



Nabaltec offers **NABALOX®** ceramic bodies with different alumina contents also as free-of-binder grades, e.g. **NABALOX®** NO 9212 C ... With the addition of necessary amount of water (approx. 20 %) these grades can be directly used for slip casting. After the application of appropriate plasticizers they are also suitable for other molding technologies (e.g. isostatic compaction, extrusion, injection molding, additive manufacturing...). Special **NABALOX®**-aluminas are also suitable for different forming techniques for engineering ceramics. Application areas for **GRANALOX®** / **NABALOX®** are listed at the end of the brochure.

Additive manufacturing

Main factors

- micronized raw materials (e.g. **NABALOX®** super-reactive alumina)
- sophisticated feedstock preparation, depending on method

Characteristics

- highly variable geometries
- very slow production
- sophisticated debinding

Recommended NABALOX®

NO 613-10, NO 615-10, NO 625-10, NO 625-31, NO 713-10, NO 725-10, NO 9212 C, NO 9622 C, NO 9915 C, NO 9922 C, NO 9980 C



Extrusion

Main factors

- easy dispersable raw materials
- high casting rates
- low water demand

Characteristics

- easy-shaped geometries (axial-symmetric), big lot sizes
- sophisticated debinding

Recommended NABALOX®

NO 325, NO 613-10, NO 615-10, NO 625-10,
NO 625-31, NO 713-10, NO 725-10,
NO 9212 C, NO 9622 C, NO 9915 C,
NO 9922 C, NO 9980 C

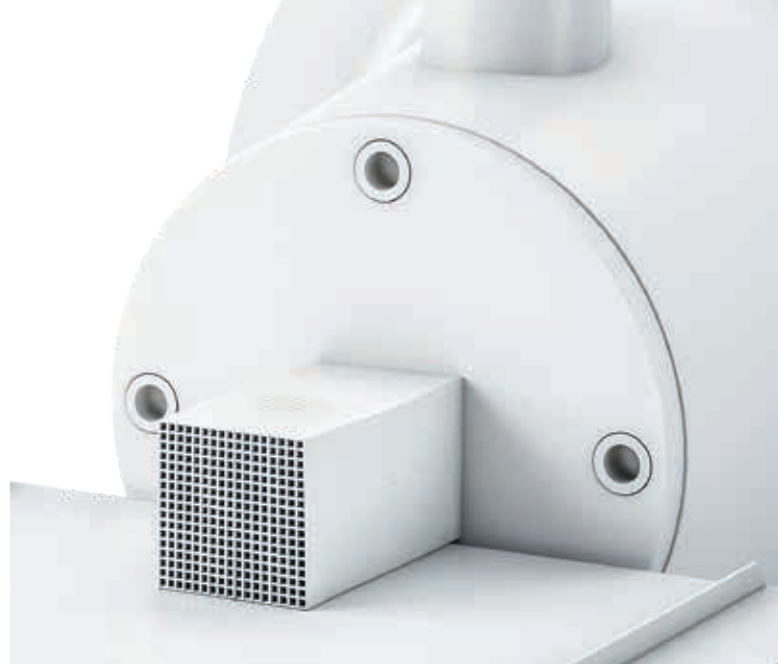

Injection moulding

Main factors

- easy dispersable raw materials
- agglomerate-free feedstock

Characteristics

- highly variable geometries
- sophisticated debinding

Recommended NABALOX®

NO 325, NO 613-10, NO 615-10,
NO 625-10, NO 713-10, NO 725-10,
NO 9212 C, NO 9622 C, NO 9915 C,
NO 9922 C, NO 9980 C

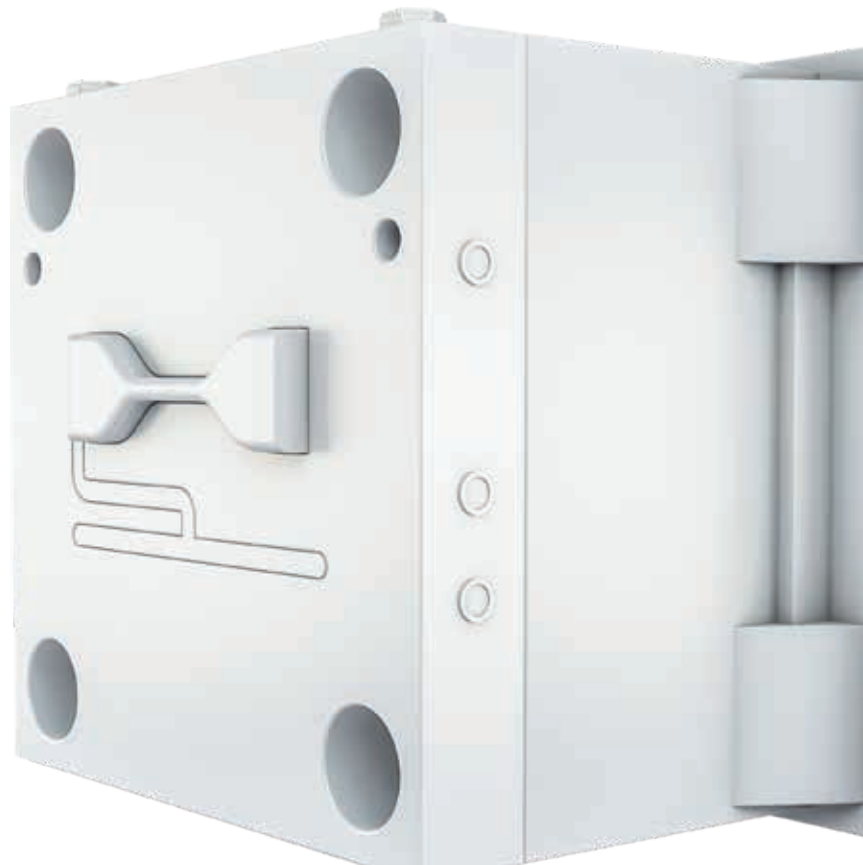

Green machining

The geometric shape of "green" alumina ceramics should be close to the final dimensions, due to the high hardness and abrasiveness of aluminium oxides. Machining of sintered parts is very costly and time consuming. The degree of green strength can be adjusted by the applied binder sys-



Green machining (cutting) of compacted **GRANALOX**[®].

tem. Due to the long-term experience and continuous development at Nabaltec, highly sophisticated systems are available. Customer specific solutions are also offered.

Nabaltec offers several **GRANALOX**[®] grades optimized for a cost effective green manufacturing. By using a designed organic formulation for special **GRANALOX**[®] grades customers are able to cut and/or drill the green types with low effort combined with high edge stability. Furthermore, Nabaltec provides **GRANALOX**[®] grades which are particularly developed for extensive green machining, e.g. after isostatic pressing.

Typical grades of **GRANALOX**[®] with optimized edge stability:

- NM 9212 G
- NM 9622 FS
- NM 9816
- NM 9970 F
- For isostatic pressing:
 - NM 9620 F
 - NM 9922 I
 - NM 9980 F
 - NM 9991 F

(s. TDS: Nabaltec.de)



Heat treatment

Debinding and Sintering

Debinding follows the forming process of the green body, and involves eliminating the organic additives used. The time and heating rate depends on the amount and type of organic additives, to avoid cracks in the green parts during their thermal treatment.

The debinding phase is critical, due to degassing of the cracked organics. This gas-evaporation process can cause fissures in the green part during this process. The technical conclusion is to ensure the amount of organics is as low as absolutely necessary. It is also advisable to choose ingredients that do not degas at the same temperature, but at a range of temperatures.

In some cases it is possible to combine debinding and sintering within the same sintering kiln.

By modifying the maximum sintering temperature combined with the dwell time the microstructure and ceramic properties can be influenced.

By using **NABALOX**[®] grades in processes such as injection moulding or slip casting, a pre-debinder step is commonly necessary. This is done by partially solvation of the binders by liquids, or a first conditioning in a drying chamber in case of slip casting.

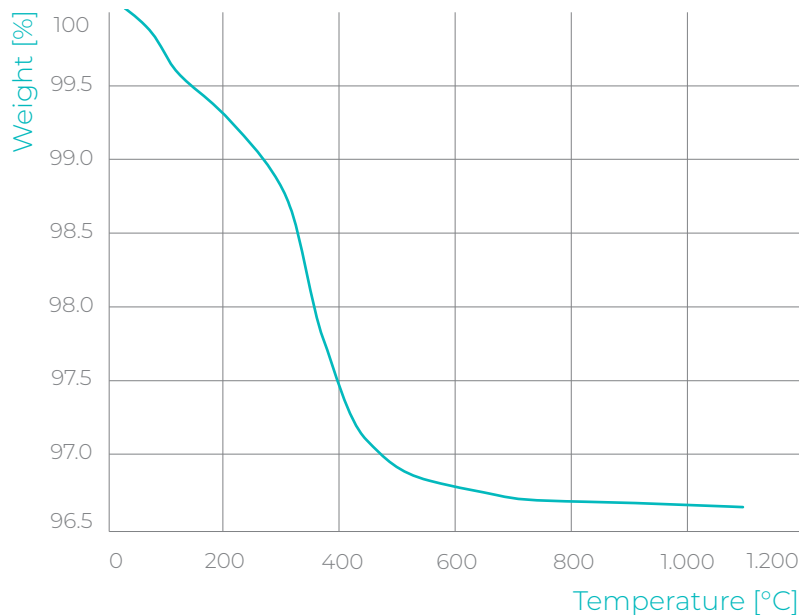

TGA (thermal gravimetric analysis) diagram of **GRANALOX**[®] showing the debinding process.

If the raw material preparation and forming processes are not adjusted optimally, e.g. agglomerates in feedstock, wrong choice of organic formulation, inhomogeneous mould filling..., the sintering process is not able to eliminate all these defects brought in the green body prior to sintering.

The densification of the microstructure starts at approx. 900 °C, shown in the dilatometric graph. To achieve dense **GRANALOX**[®] / **NABALOX**[®]-ceramics, common sintering temperatures for 92 to 99.8 % Al₂O₃ grades are in the range of 1550 – 1650 °C. The volume

decrease between green body and dense ceramic is measured via dilatometry and calculated as the isotropic linear shrinkage. This is a key factor for the ceramist to determine the dimensions of the final sintered ceramic part.

The necessary sintering temperature depends mainly on the size of the primary crystals according to the specific surface area (BET). For 2 μm -particles of e.g. **NABALOX**[®] NO 725-10 (BET 2 m^2/g) a maximum sintering temperature of 1750 $^{\circ}\text{C}$ is needed for densification. In comparison, by using **NABALOX**[®] NO 713-10 (0.5 μm primary crystals, BET 7 m^2/g) a significant lower temperature of 1600 $^{\circ}\text{C}$ is recommended for adequate sintering.

The microstructure and sintering temperature can also be influenced by addition of a specific glassy phase (e.g. **GRANALOX**[®] NM 92 to NM 98, s. SEM images next page). Furthermore, resulting ceramic properties like elastic modulus, breaking strength, ability to metallization..., are influenced by addition of glassy phases containing CaO, MgO, SiO₂.

The ceramic properties for solid state sintering mainly depend on specific surface area and primary crystal size of the **NABALOX**[®] types. In the case of NM 99 no glassy phases are necessary for producing engineering ceramics (e.g. air separator wheels, ceramic screws,...).

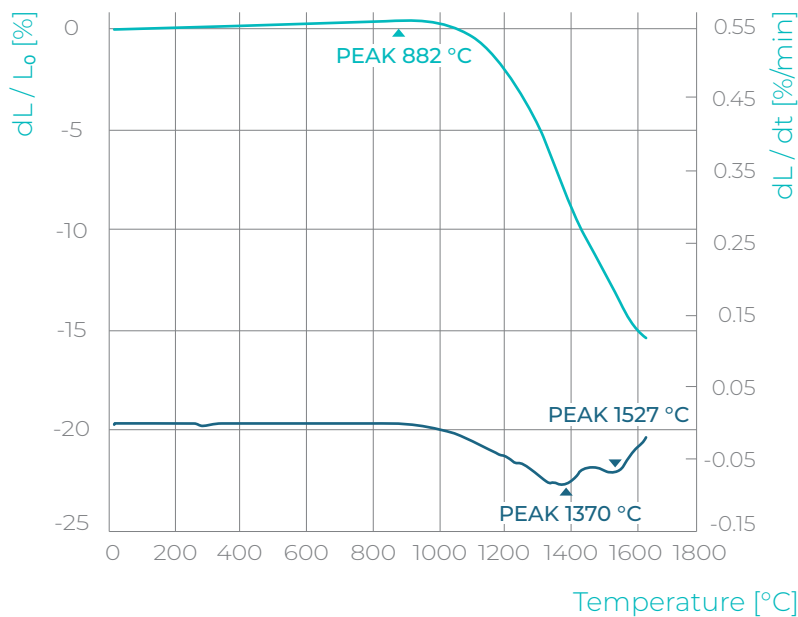

Thermal elongation (blue), thermal expansion (red); thermal expansion rate of 99.7 % Al₂O₃-**GRANALOX**[®].

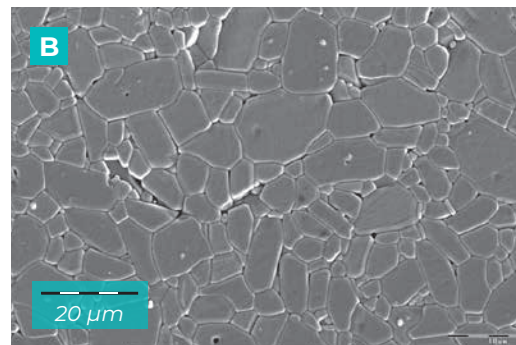
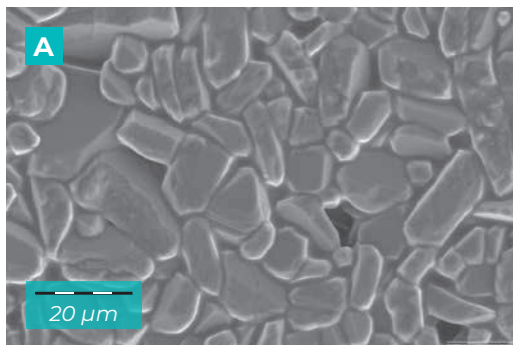

Thermally etched microstructure of glassy phase bonded **GRANALOX**[®]
A: NM 92 to NM 98, B: Solid state sintered (no glassy phase) NM 99.



Finishing

Finishing

After sintering different types of finishing are used to give the ceramic parts their final dimension and surface quality.

The following methods are typically used:

- cutting
- drilling
- grinding
- lapping
- polishing

As ceramic parts made from **GRANALOX**[®]- and **NABALOX**[®]-alumina are very hard, consequently finishing of these ceramics is rather costly and also time consum-

ing. It therefore should be restricted to an absolute minimum. The most common finishing step is polishing to achieve the requested tolerances down to micron-scale. The processing speed and achievable surface quality can be significantly influenced by the design of the microstructure.

- This includes:
- crystal size
- crystal size distribution
- volume of glassy phase

Further information about pressing and sintering details of **NABALOX**[®] and **GRANALOX**[®], see technical data sheets or in the appendix.

Technical ceramics applications (in excerpts)

	Ballistic protection	Catalyst carrier	Spark plug insulator	Electronic housing	Electronic substrates	Wear protection (abrasion/friction)	Chemical engineering	Medical technology	High temperature ceramics	High strength machinery parts	Additive manufacturing, ceramics	Extrusion	Ceramic injection molding	Slip casting	Uniaxial pressing	Isostatic pressing
GRANALOX®																
NM 9212 E						•									•	
NM 9212 F						•									•	•
NM 9212 G						•									•	
NM 9510 F				•	•										•	•
NM 9620							•								•	
NM 9620 F				•	•			•							•	•
NM 9622	•		•	•	•					•					•	
NM 9622 F					•					•					•	•
NM 9622 FS										•					•	
NM 9622 W										•					•	
NM 9634 F															•	•
NM 9816	•									•					•	
NM 9916 F										•					•	•
NM 9922	•	•				•	•	•	•	•					•	
NM 9922 F								•	•	•					•	•
NM 9922 I								•	•						•	•
NM 9970 F								•	•						•	•
NM 9980 F								•	•						•	•
NM 9991 F								•	•						•	•
NM ZTA12								•	•						•	•
NABALOX®																
NO 105 RA	•		•	•	•	•	•		•	•						
NO 105-71 RA	•		•	•	•		•		•							
NO 115 TC	•	•		•	•	•	•		•							
NO 313		•														
NO 315		•		•	•		•		•							
NO 325				•	•		•		•					•		
NO 613-10		•				•	•		•					•		
NO 615-10	•			•	•	•	•		•					•		
NO 625-10	•			•	•	•	•		•					•		
NO 625-31							•		•		•			•		
NO 713-10	•	•				•	•	•	•	•	•	•	•	•	•	
NO 725-10	•			•	•	•	•		•	•	•	•	•	•	•	
NO 9212 C										•	•	•	•	•		
NO 9622 C				•						•	•	•	•	•		
NO 9915 C										•	•	•	•	•		
NO 9922 C									•	•	•	•	•	•		
NO 9980 C					•					•	•	•	•	•		



Service
for our customers

Service

for our customers

Technical service development / production

Nabaltec AG develops new products and refines innovative products in close cooperation with our customers and raw material suppliers.

Here we use our own lab facilities as well as our excellent contacts to external test institutes and laboratories to offer our customers a wide range of service to support them in formulation development and test procedures.

The successful implementation of this development and the intensive customer consultations enable Nabaltec AG an interaction with our customers in a cooperative, responsible and innovative manner. This culminates in the development of high performance products at the customer as well as in our facility.

Additionally, we have the capacity to fashion tailor made products for special customer requirements and their highly sophisticated and demanding markets.

Laboratory services

Our analysis centre is responsible for independent production control and quality offers laboratory services for customers intending to use our large analytical equipment.

With this excellent equipment we are able to execute analytic tests in the area of inorganic solids, trace elements and water quality.

The certification in accordance with DIN EN ISO 17025 confirms the high service standards of our lab.

We will gladly inform you about our capabilities.

Nabaltec

product portfolio

ACTILOX®

Boehmite, as flame retardant filler and catalyst carrier

APYRAL® AOH

Boehmite, as flame retardant filler and functional filler

APYRAL®

Aluminium hydroxides, as flame retardant and functional filler

GRANALOX®

Ceramic bodies, for the production of engineering ceramics

NABALOX®

Aluminium oxides, for the production of ceramic, refractory and polishing products

Nabaltec

worldwide

Visit us at our website www.nabaltec.de where you will find the latest company updates and recent versions of all available certificates free for download as PDF-documents.

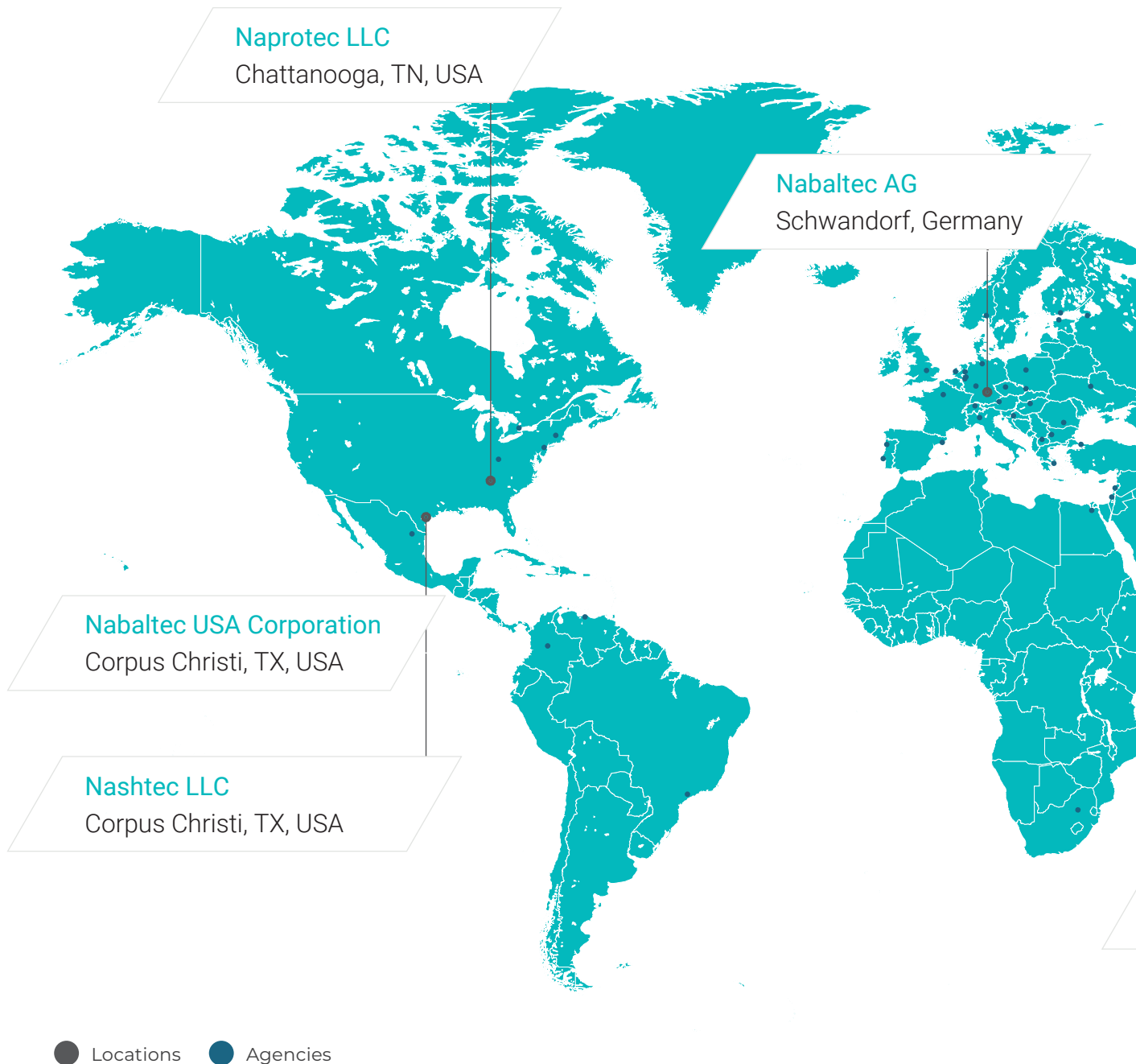



Nabaltec (Shanghai) Trading Co., Ltd.
Shanghai, China

Further information:

Nabaltec AG

P.O. Box 1860 · 92409 Schwandorf

Phone +49 9431 53-0

www.nabaltec.de

info@nabaltec.de

Customer Service

Phone +49 9431 53 910

sales@nabaltec.de

Technical Service

Phone +49 9431 53 920

tec-service@nabaltec.de

Nabaltec AG

P.O. Box 1860 · 92409 Schwandorf

Tel +49 9431 53-0

Fax +49 9431 61 557

www.nabaltec.de

info@nabaltec.de

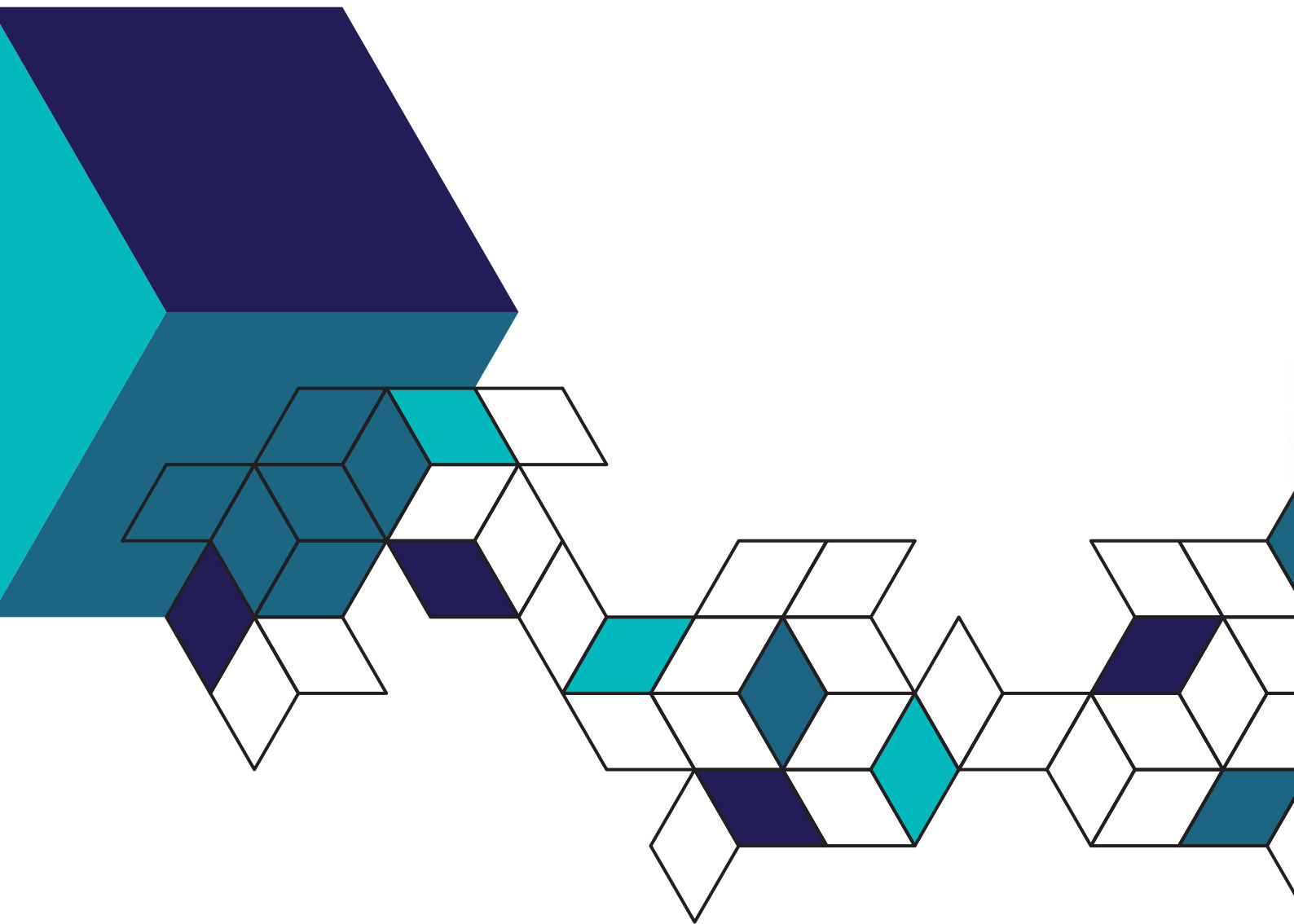

All data listed in this brochure are reference values and subject to production tolerance. These values are exclusive to the product description and no guarantee is placed on the properties. It remains the responsibility of the users to test the suitability of the product for their application.